

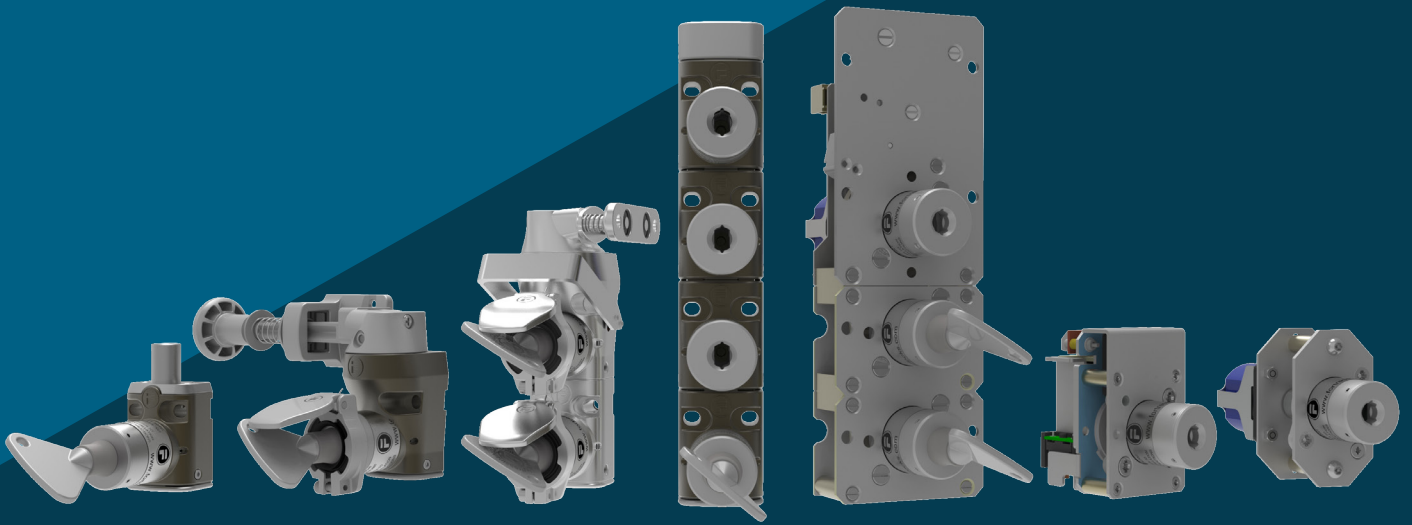

# FORTRESS



## Mechanical Trapped Key Interlocks Certified to PLe



THE QUEEN'S AWARDS  
FOR ENTERPRISE:  
INTERNATIONAL TRADE  
2018



C



US



# Introduction to mGard

mGard is the only range of trapped key interlocks 3rd party approved as meeting PLe and is perfect for heavy duty applications. Fortress' mGard is suitable for use up to SIL3 (EN/IEC 62061), Category 4 and PLe (EN/ISO 13849-1).

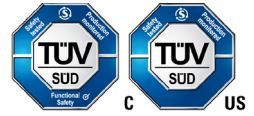

Trapped key interlocking is a tried and tested method of mechanically safeguarding dangerous machines and hazardous processes. Mechanical keys eliminate most of the electrical wiring associated with other types of interlocks making it cost effective to install and maintain.

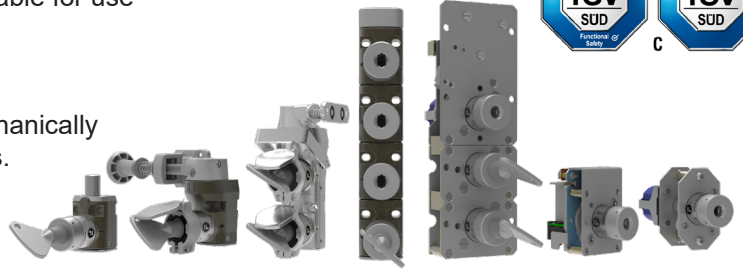

## Why Interlocks?

Interlocking is a method of controlling two or more interdependent operations which must take place in a predetermined sequence, if necessary remotely controlled or time delayed. The need for this sequence may be safety to personnel and equipment, or it may be to control processes and productivity.

### For Reference-

- ISO 14119 is the interlocking standard that forms part of the machinery directive.
- ISO/TS 19837:2018 is the technical specification relevant to trapped key interlocking.

## Why Mechanical?

- One power isolator can be used for multiple doors through the use of a key exchange unit.
- This reduces any fault masking risks and wiring installation required.
- In addition mechanical interlocking is the only method of safeguarding solutions for multiple energy sources.
- Personnel keys can be used to prevent unexpected start up of machinery as per ISO 14118, removing the necessity for escape functions.

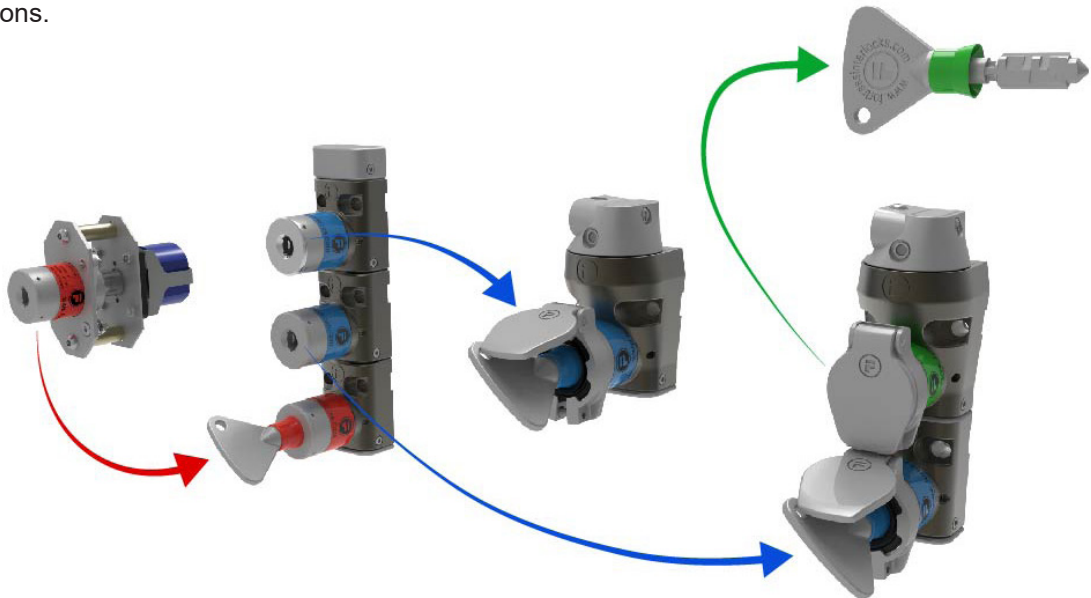

**Key Operated Switch    Key Exchange Device    Access Lock    Access lock with Personnel Key**

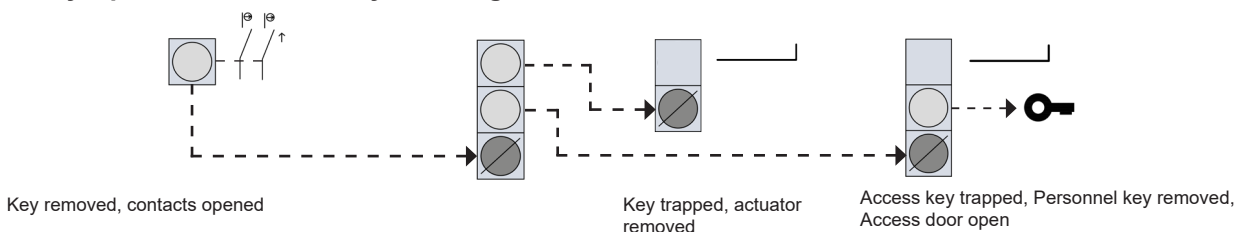

## Application Requirement:

This robot welding cell's safety system must only allow operators to enter the cells when power to the cell has been isolated and the machinery has come to a controlled stop after a defined run-down time. After access, the system prevents unexpected start up when multiple operators are performing maintenance, via Personnel Keys.

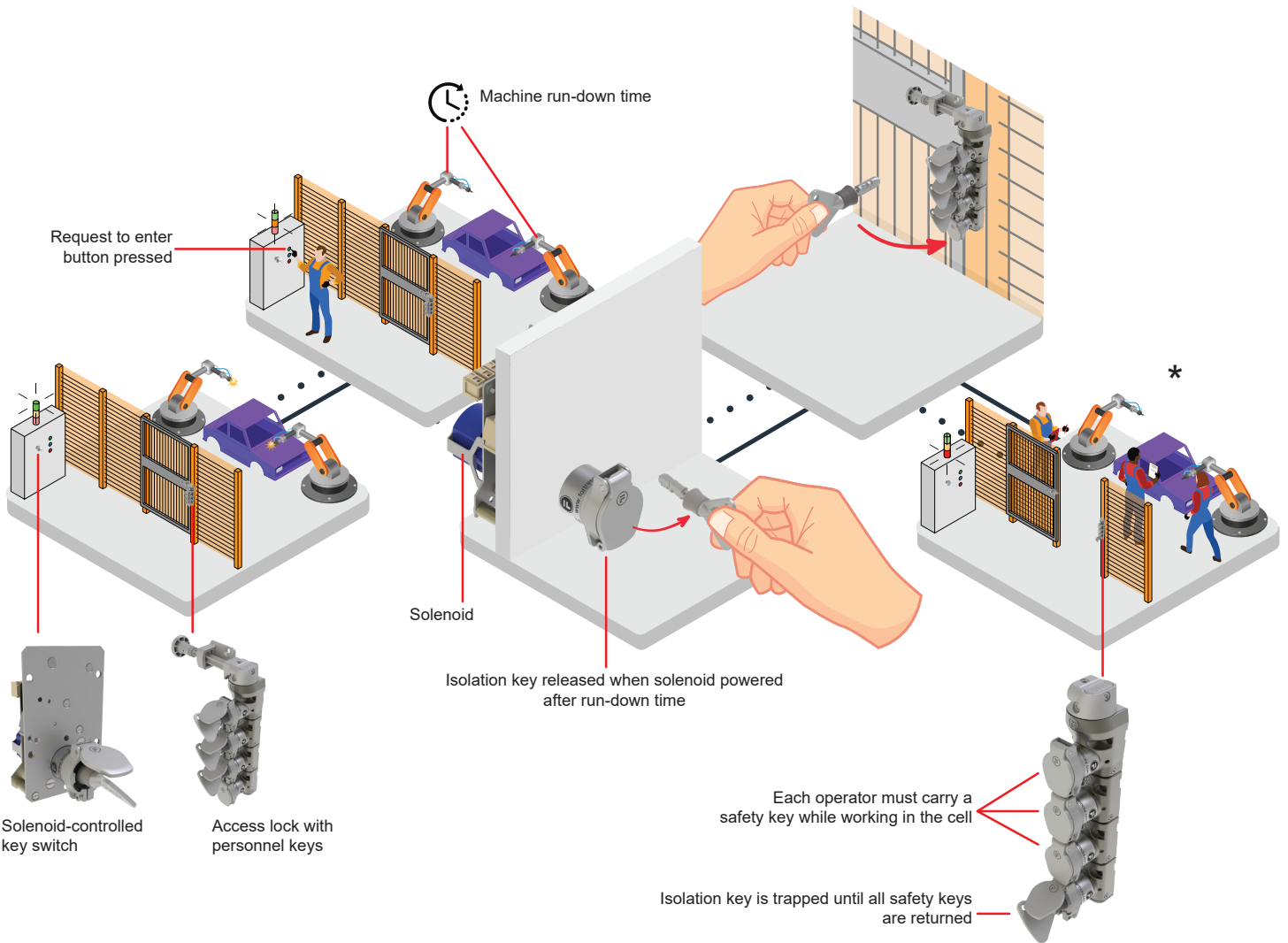
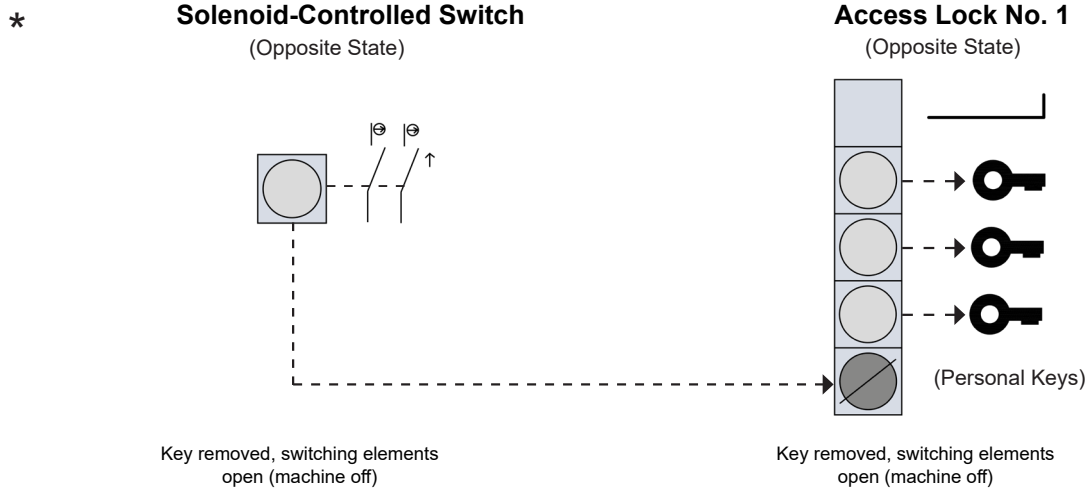

## Application Requirement:

Industrial concrete mixers have multiple access hatches that are safeguarded by mechanical interlocks. These access hatches are opened for scheduled cleaning under the protection of the installed safety system. Access is only allowed once the power switch to the mixer has been mechanically isolated.

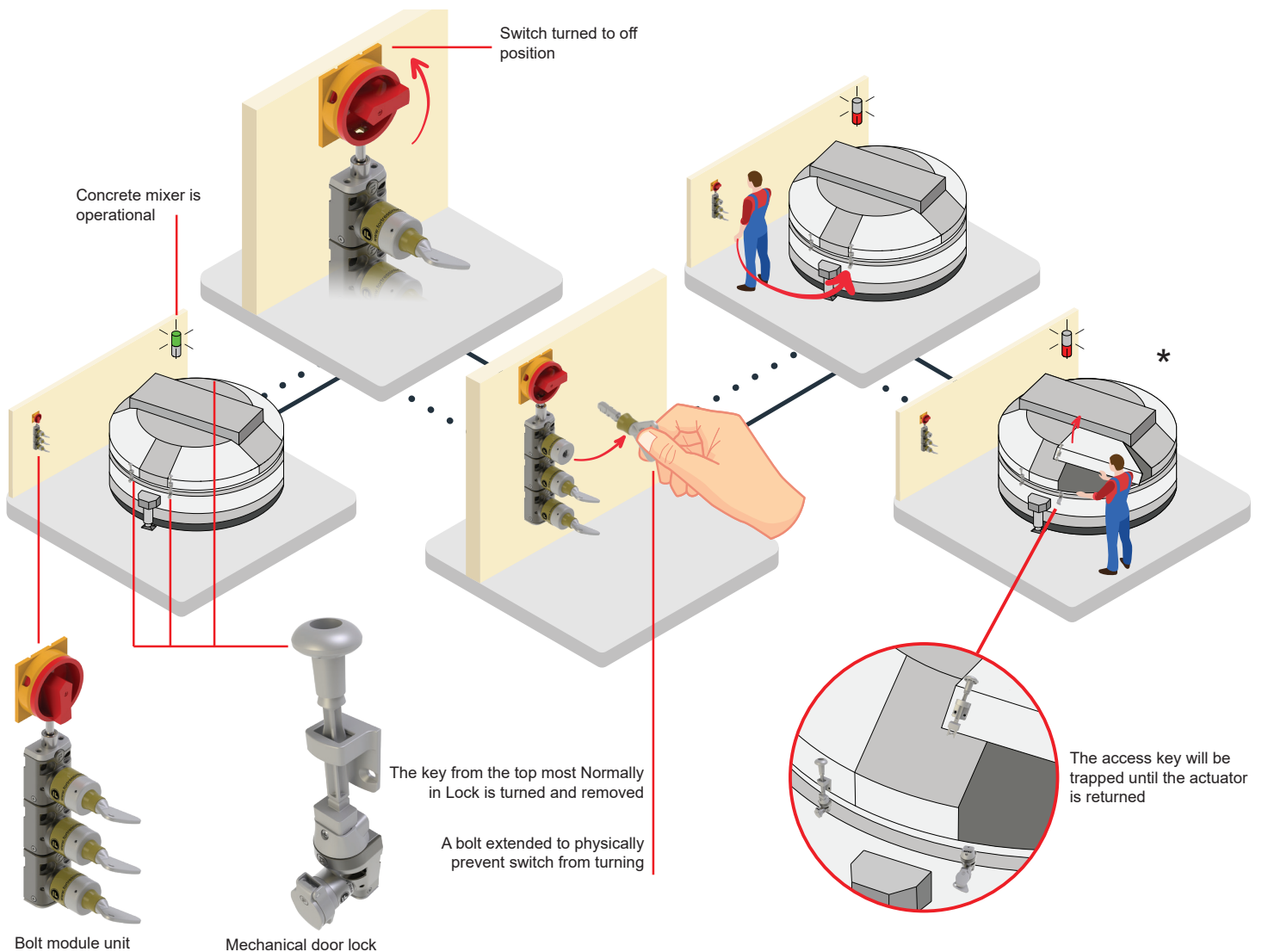
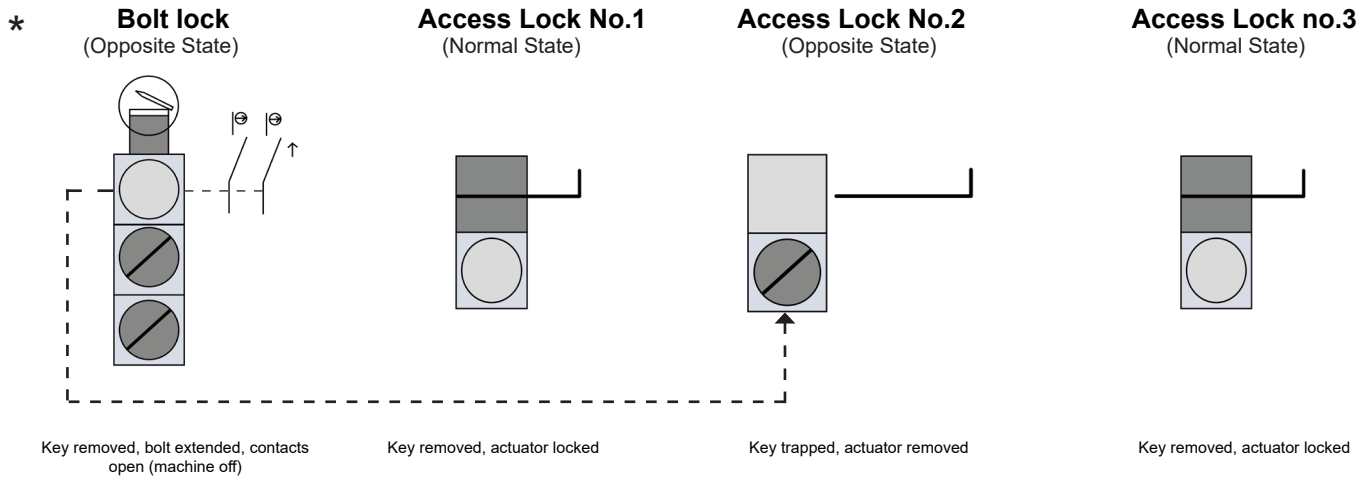



## Application Requirement:

The double backer machines enclosed in two cells requires extensive safeguarding. A safety system for the cells should ensure operators and maintenance personnel can only enter the areas once power to all of the machinery has been isolated and has come to a controlled stop.

### \* Time Delay Device

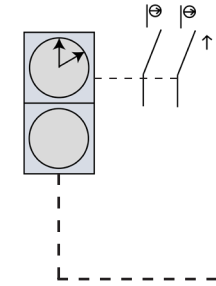

Key removed, switching elements open (machine off).

### Key Exchange Device

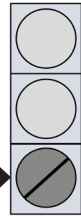

### Access Lock with Personnel Key No.1

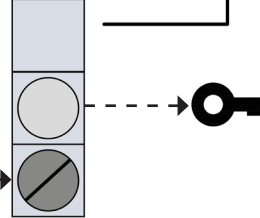

Access key trapped, Personnel key removed, Access door open.

### Access Lock with Personnel Key No.2

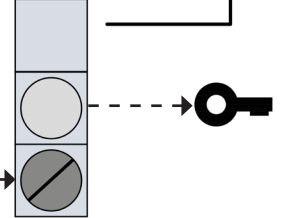

Access key trapped, Personnel key removed, Access door open.

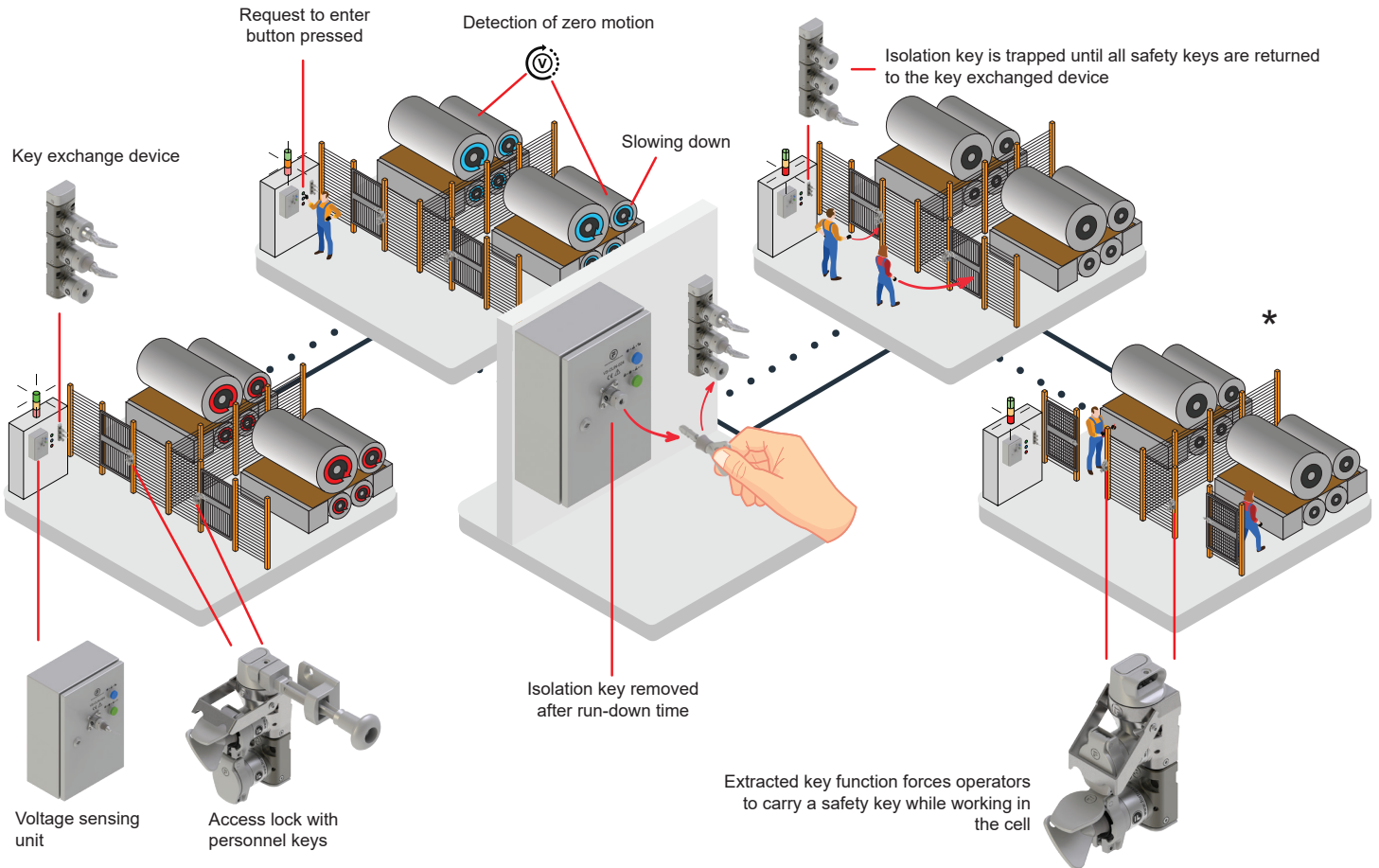

## Valves & Pneumatic Interlocks

Fortress supplies a range of interlocks suitable for valve applications and for pneumatic isolation. With the incorporation of a mechanical module and key to a valve, Fortress has created a simplified solution for controlling the position of the valve and isolating the valve movement without the need of levers or hand-wheels in other forms of valve interlocking/lockout.

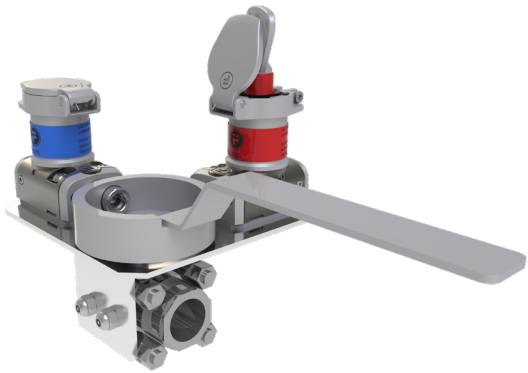

### Valve Application 2

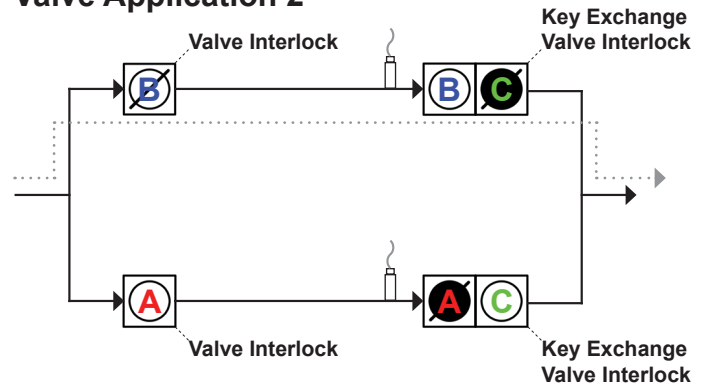

### Valve Application 1

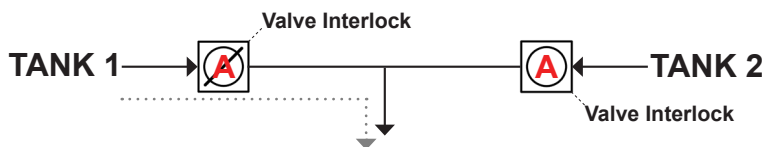

In this application, only one of the tanks can feed into the supply at once. The use of Valve Interlocks insures only one of the lines can be open because the two interlocks share a single key. Each valve can only be opened while a key is trapped to the locked position in the interlock.

In this application, at least one pressure release line must be open at all times. The use of the Valve Interlocks insures at least one line will always be open because the independent interlocks A and B require their corresponding key to be turned to the locked position to close the valve. The two Key Exchange Interlocks share one key for the two locks marked C. The key for the two C locks is transferred between the units to always trap either the A or B key.

## Specials and Custom Units for Applications

Over the years, Fortress has produced many special-purpose units designed to meet the specific needs of its customers and applications within their industries. Some of these units include: standalone time delay/voltage sensing and elaborate key sequencing exchange boxes. Some of these units have been added to the mGard range as their popularity in applications has grown throughout the years, but are considered non-standard or specials solutions due to the extended lead time required to design and manufacture. Fortress have recently developed a trapped key range with third party approved ATEX and IECEx approval for safe use in explosive atmospheres and hazardous locations.

Fortress has also helped customers create completely custom units that were specific to one individual application. These units were created in collaboration with engineers between both parties to better understand the needs and constraints of the application. Fortress is pleased to offer advice and assist without obligation; although a simpler solution may be proposed through standard mGard units or the other ranges Fortress has to offer.

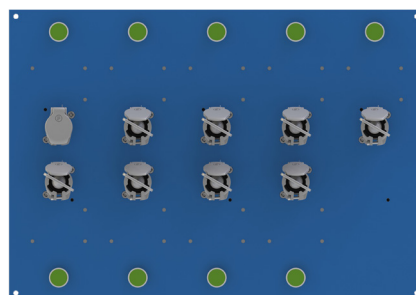

# Definitions & Sequencing

Fortress trapped key solutions are designed to allow a multitude of sequencing options to match your specific applications. Before we discuss some different sequences, there are some definitions which help understand the 'state' of a product at a given moment.

## Definitions

**Product State** - the condition a product is in relating to locks (and if applicable) switch contacts.

**Normal State** – is a condition of a 'device' which the part number will describe. Typically, Normal State is referred to as the machine is running, switches are in their 'normal' position (normally closed and normally open), and access to any hazardous space is not permitted.



**Opposite State** – is the opposite of the normal state. Typically, opposite state is defined as machine isolated, with any access doors opened with operators performing whole or partial body access.



**Transition State** – is any point within the transition of a product being operated from its Normal State to reach its Opposite state.

**Lock States** - the condition of a lock relating to operable keys.

The mGard range of products allows keys to be transferred from different devices to perform specific functions. In this sequence, the operation of a key can change. A key could be used for both isolating a switch, and to access the entryway to a safeguarded space.

**Lock Group** – All locks of one state within a product (i.e., all Normally In Locks, or all Normally Out Locks).

**Normally In Locks (NIL)** – Locks with a key inserted and trapped (rotated clockwise 120°) in position.

**Normally Out Locks (NOL)** – Locks with no key inserted or trapped (empty locks).

**Sequences** - The order of operation of locks within a given product

**Fully Sequenced** – Locks of a given Lock Group must operate in order starting by removing the key from the top-most lock, followed by the adjacent lock and so on. (When keys are inserted, the keys must be entered into the bottom most lock first, and inserted in order, with the key entered into the top-most lock of the given group last).

**Partially Sequenced** – The top-most lock of a given Lock Group must be operated first (key removed), followed by any remaining locks in that group in any order. (When keys are inserted, the top-most lock must be operated last).

**Non-Sequenced** - Locks within a given Lock Group can be operated in any order. No specific lock must be operated first.

**Standard Sequence Types** - How the NIL and NOL locks operate for a given product. In this brochure, the standard sequence will be listed for each product type.

## Sequencing



Sequence Letter	Normally In Locks	Normally Out Locks	Type of Lock at top of product
Z	Partially Sequential	Partially Sequential	Normally In Lock (NIL)
Y	Non-Sequential	Non-Sequential	Normally In Lock (NIL)
W	Partially Sequential	Non-Sequential	Normally In Lock (NIL)
V	Fully Sequential	Fully Sequential	Normally In Lock (NIL)
Historical Fortress Sequencing – Sequence 'X' swaps the positions of the Normally In and Normally Out Locks. If you are trying to match an existing Fortress 'XM' product, you may require sequence 'X'.			
X	Non-Sequential	Non-Sequential	Normally Out Lock (NOL)

# Power Isolation

## Control Interlocking

Panel Mounted

Panel Mounted Weatherproof

In Enclosure

Knob Operated Switch Control Unit

## Power Interlocking

Mechanical Bolt Interlock

Bolt Interlock with Limit Switch

Key Switch(es)

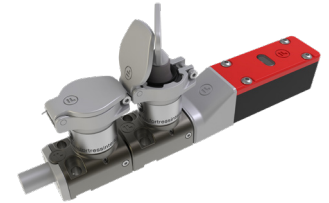

Mini Solenoid Controlled Key Switch(es)

Key Operated Switch Control Unit

Bolt Interlock with Switch

Circuit Breakers



Solenoid Controlled Key Switch(es)

Electronic Time Delay Unit

Valve & Pneumatic Interlocks

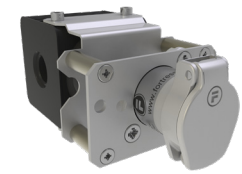

ATEX and IECEX Approved Solenoid Controlled Switch

ATEX and IECEX Approved Key Switch

Voltage Sensing Unit



## Key Exchange

Modular Key Exchange Unit



Modular Key Unit with Switch(es)



## Door Locks

Single Door Interlock



Multiple Modular Door Interlock



Forced Safety Key Door Interlock

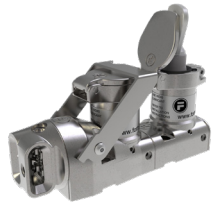

All in One Door Interlocks



## Actuators

Fixed Actuator

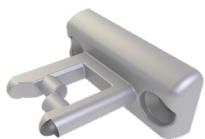

Handle Operated Actuator

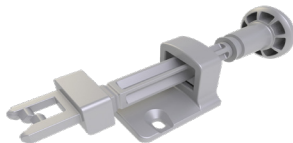

Spring Released Handle Operated Actuator



Compressible Actuator

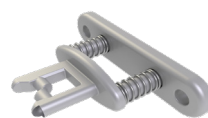

Self Aligning Actuator



## Keys & Locks

Standard



Masterable



Colours available for key seal and lock label.

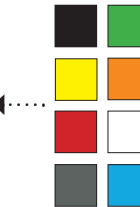
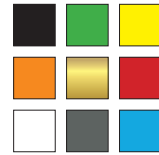

Colours available for key bow and dustcovers.



3 lines of 10 characters available for engravings.

Low Profile

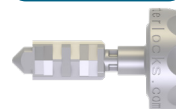

## Accessories

Extension Module



Dustcovers (Available as Standard & Padlockable)



Lockout Hasps (For 3x Padlocks)



Back of Board Mounting Kit

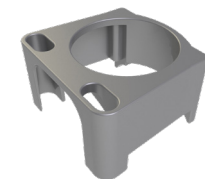



## Bolt Module Unit

Standard Sequence	
Z	Normally In Locks - Partially sequential Normally Out Locks - Partially sequential



XMA Unit

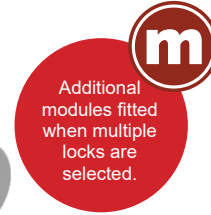

Additional modules fitted when multiple locks are selected.

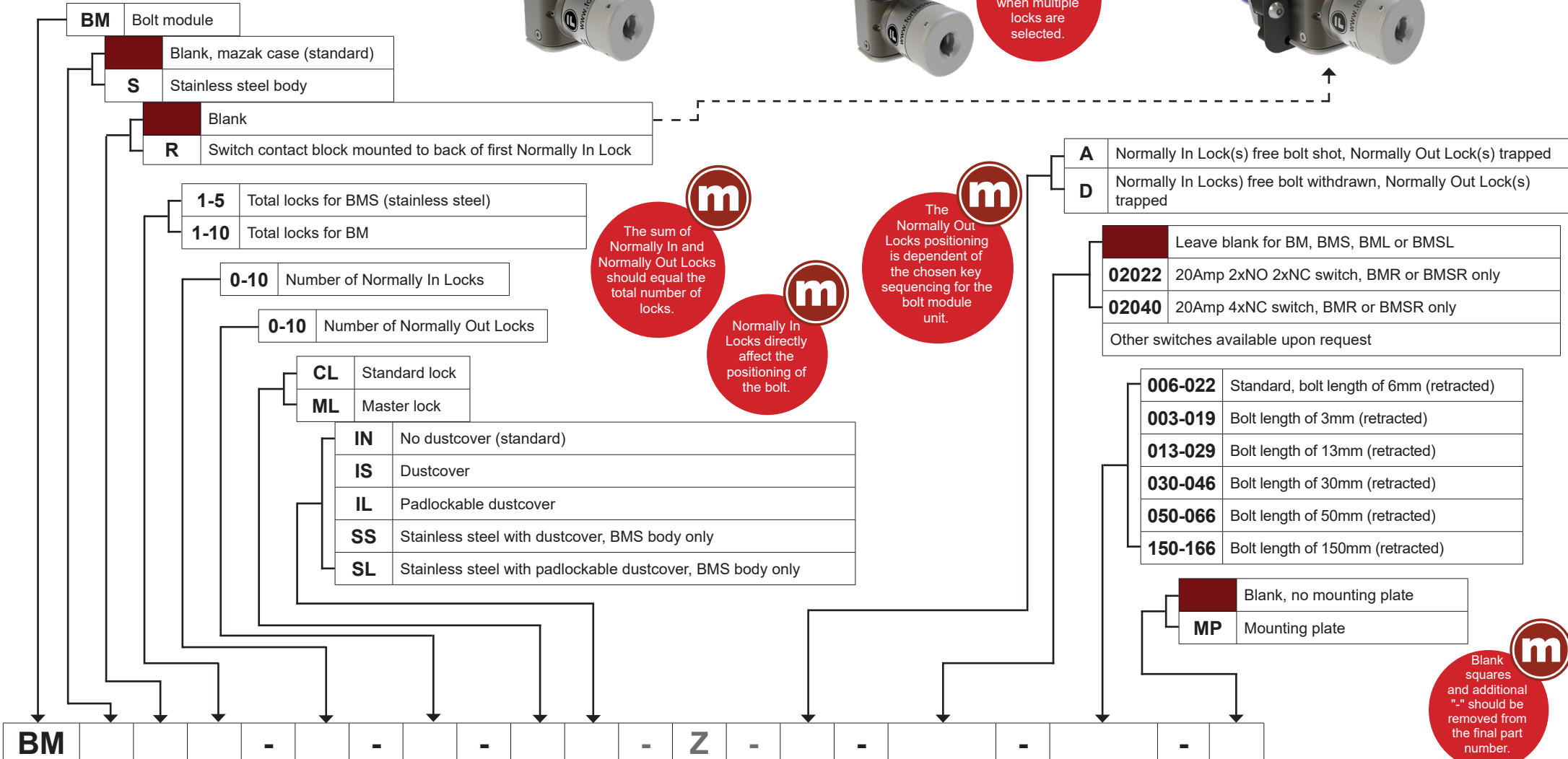



## Key Operated Switch

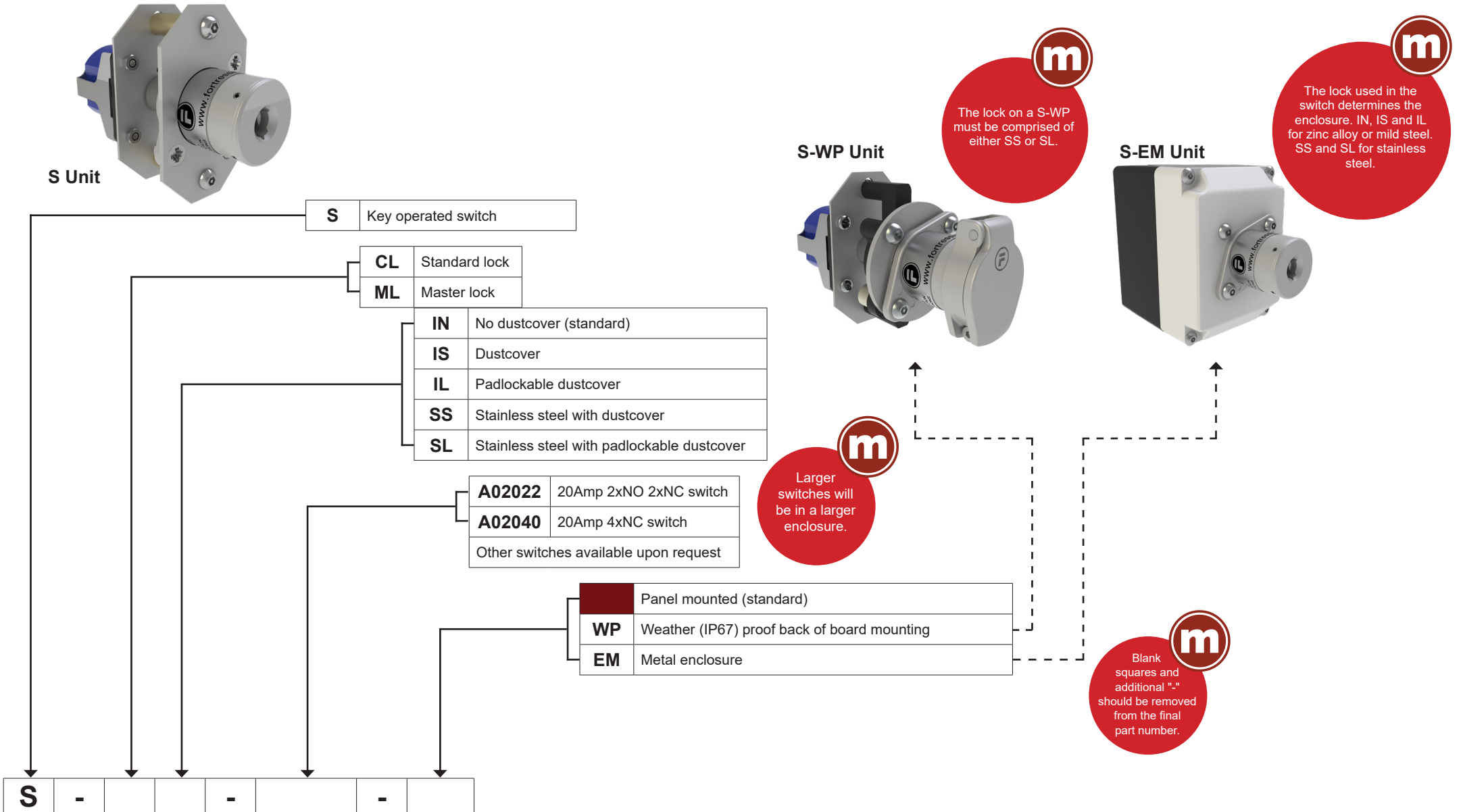

## Solenoid Controlled Key Switch

SS1-B



The number of Normally Out Locks (NOL) is typically '0'.



The sum of Normally In and Normally Out Locks should equal the total number.

Standard Sequence	
V	Normally In Locks - Fully sequential Normally Out Locks - Fully sequential

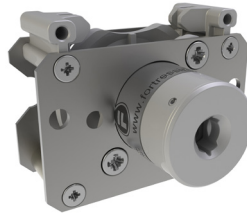

Add-on lock modules are fitted to the solenoid if multiple keys are released by the solenoid.

SS1-WP

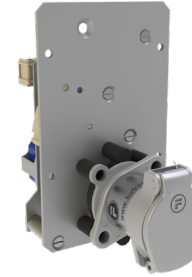

SS1-F



**SS** Solenoid controlled key switch

**1-10** Total number of locks

**1-10** Number of keys freed when solenoid is energised (Normally In)

**0-9** Number of keys trapped when solenoid is energised (Normally Out)

**CL** Standard lock

**ML** Master lock

**IN** No dustcover (standard)

**IS** Dustcover

**IL** Padlockable dustcover

**SS** Stainless steel with dustcover

**SL** Stainless steel with padlockable dustcover

**A** Switch only on solenoid lock

**B** Switch on solenoid lock & first Add-on lock

**02022** 20Amp 2xNO 2xNC switch

**02040** 20Amp 4xNC switch

Other switches available upon request

**A** AC

**D** DC

**024** 24v (DC only)

**048** 48v (DC only)

**110** 110v (DC or AC)

**230** 230v (AC only)

**PU** Power-to-Unlock solenoid



Blank squares and additional "." should be removed from the final part number.

**V** Locks arranged vertically

**01** 1 row

**C** Cam sequence

**B** Back of board mounting

**WP** Weather (IP67) proof back of board mounting

**FB** Mild steel painted blue fabrication

**FR** Mild steel painted red fabrication

**FRAL#** Mild steel painted to specific RAL number

**FS** Stainless steel IP66 fabrication



## Mini Solenoid Controlled Key Switch

MSS Unit



**MSS** Solenoid controlled key switch

**1** One key freed when solenoid is energised

**0** Zero keys trapped when solenoid is energised

**CL** Standard lock  
**ML** Master lock

**IN** No dustcover (standard)  
**IS** Dustcover  
**IL** Padlockable dustcover  
**SS** Stainless steel with dustcover  
**SL** Stainless steel with padlockable dustcover

**A00302** 3amp 2xnc switch

**A** AC  
**D** DC  
**024** 24v (DC only)  
**048** 48v (DC only)  
**110** 110v (DC or AC)  
**230** 230v (AC only)

**PU** Power-to-Unlock solenoid

**Panel mounted (standard)**  
**WP** Weather (IP67) proof back of board mounting  
**EM** Metal enclosure (option pod), 24v DC solenoid only



**m**  
The contact block in the mini solenoid controlled key switch are only available as a 3Amp 2xNC switch.

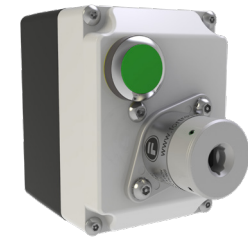

MSS-WP Unit

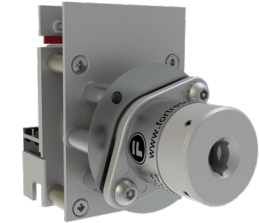

**m**  
The solenoid used in the mini solenoid controlled key switch are all Power-to-Unlock.

**m**  
MSS-WP panel thickness must be 1.5 - 3.5 mm.

**m**  
Blank squares and additional "-" should be removed from the final part number.

## Time Delay and Voltage Sensing

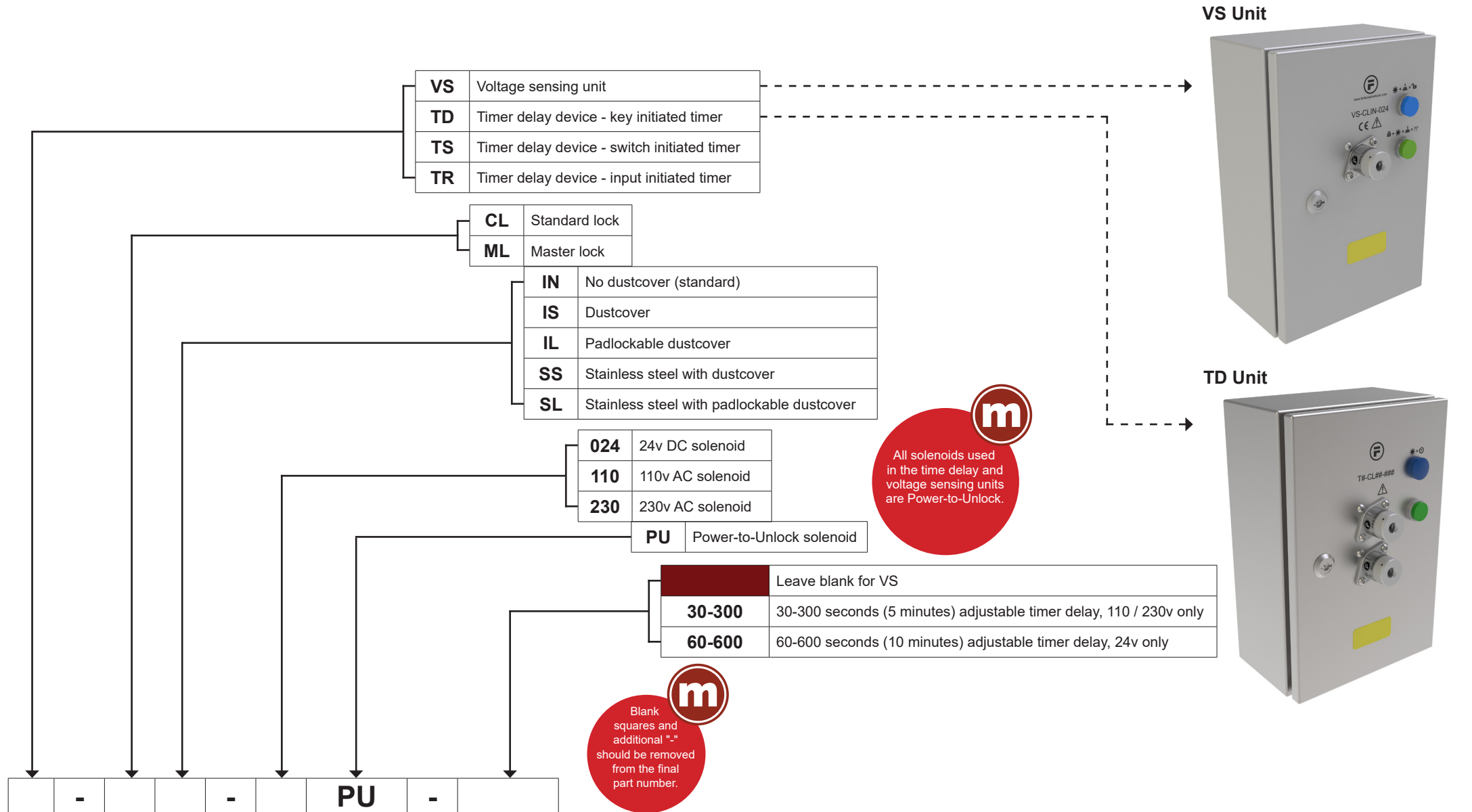

## Switch Control Unit

SCU1-B Unit

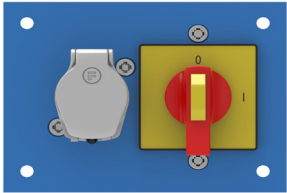

LCU4-B Unit



Standard Sequence	
V	Normally In Locks - Fully sequential Normally Out Locks - Fully sequential

<b>SCU</b>	Knob operated switch control
<b>LCU</b>	Lock operated switch control

<b>1-7</b>	Total number of locks for SCU
<b>2-8</b>	Total number of locks for LCU

<b>1-7</b>	Number of keys trapped in a LCU (NIL)
------------	---------------------------------------

<b>0-7</b>	Number of keys freed in a SCU/LCU (NOL)
------------	---

<b>CL</b>	Standard lock
<b>ML</b>	Master lock
<b>IN</b>	No dustcover (standard)
<b>IS</b>	Dustcover
<b>IL</b>	Padlockable dustcover
<b>SS</b>	Stainless steel with dustcover
<b>SL</b>	Stainless steel with padlockable dustcover

**m**  
The sum of Normally In and Normally Out Locks should equal the total number of locks.

**m**  
The number of Normally Out Locks (NOL) is typically '0'.

<b>A</b>	Switch only on control lock/knob
<b>B</b>	Switch on control lock/knob and Normally In Locks
<b>02022</b>	20Amp 2xNO 2xNC switch
<b>02040</b>	20Amp 4xNC switch
Other switches available upon request	

<b>H</b>	Locks arranged horizontally
<b>V</b>	Locks arranged vertically

<b>01</b>	1 row (standard)
-----------	------------------

<b>C</b>	Cam sequence, not available on 2 row units
<b>R</b>	Runner bar sequence

<b>B</b>	Back of board mounting
<b>FB</b>	Mild steel painted blue fabrication
<b>FR</b>	Mild steel painted red fabrication
<b>FRAL#</b>	Mild steel painted to specific RAL number
<b>FS</b>	Stainless steel IP66 fabrication

**m**  
Blank squares and additional "-" should be removed from the final part number.



## Key Exchange Units

**XM2 Unit**



Blank squares and additional "-" should be removed from the final part number.



**XMR2 Unit**



The sum of Normally In and Normally Out Locks should equal the total number of keys.



**XM-LINK-ST401 unit**

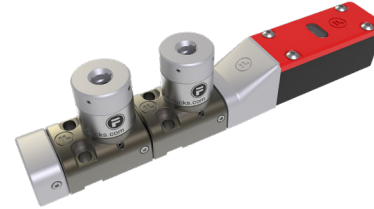

**XMA Unit**



Additional modules fitted when multiple locks are selected.

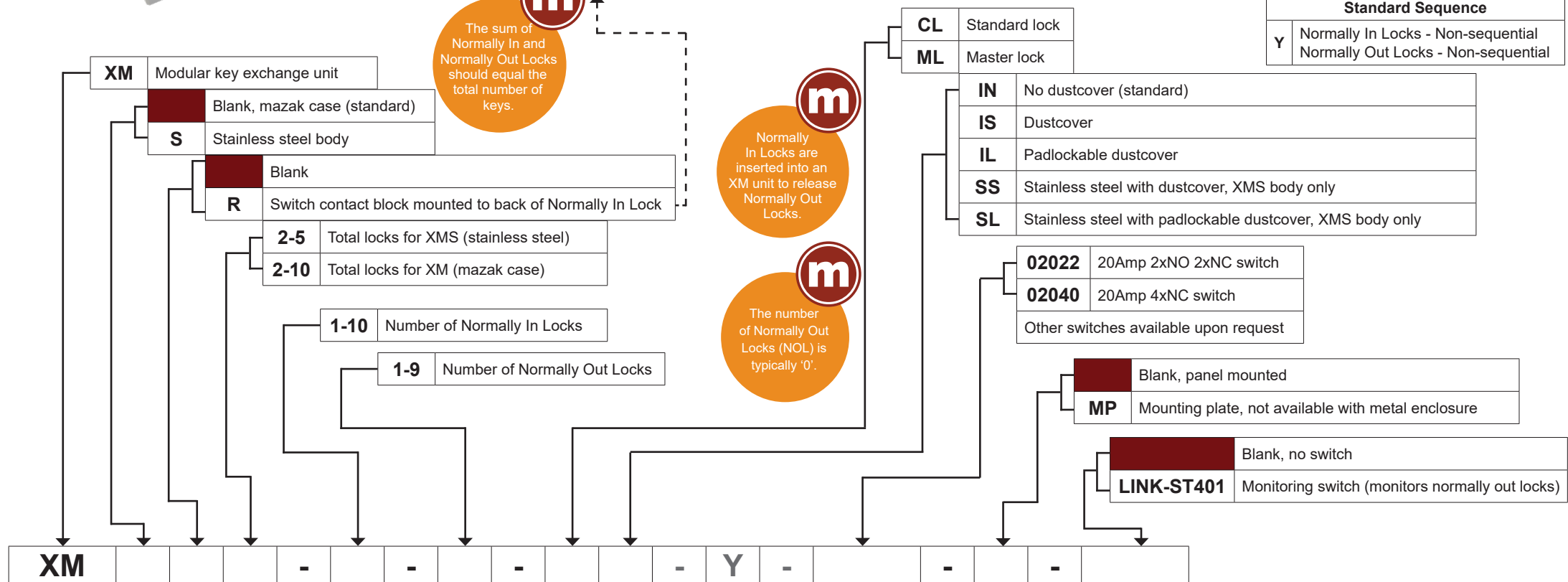



## Door Locks

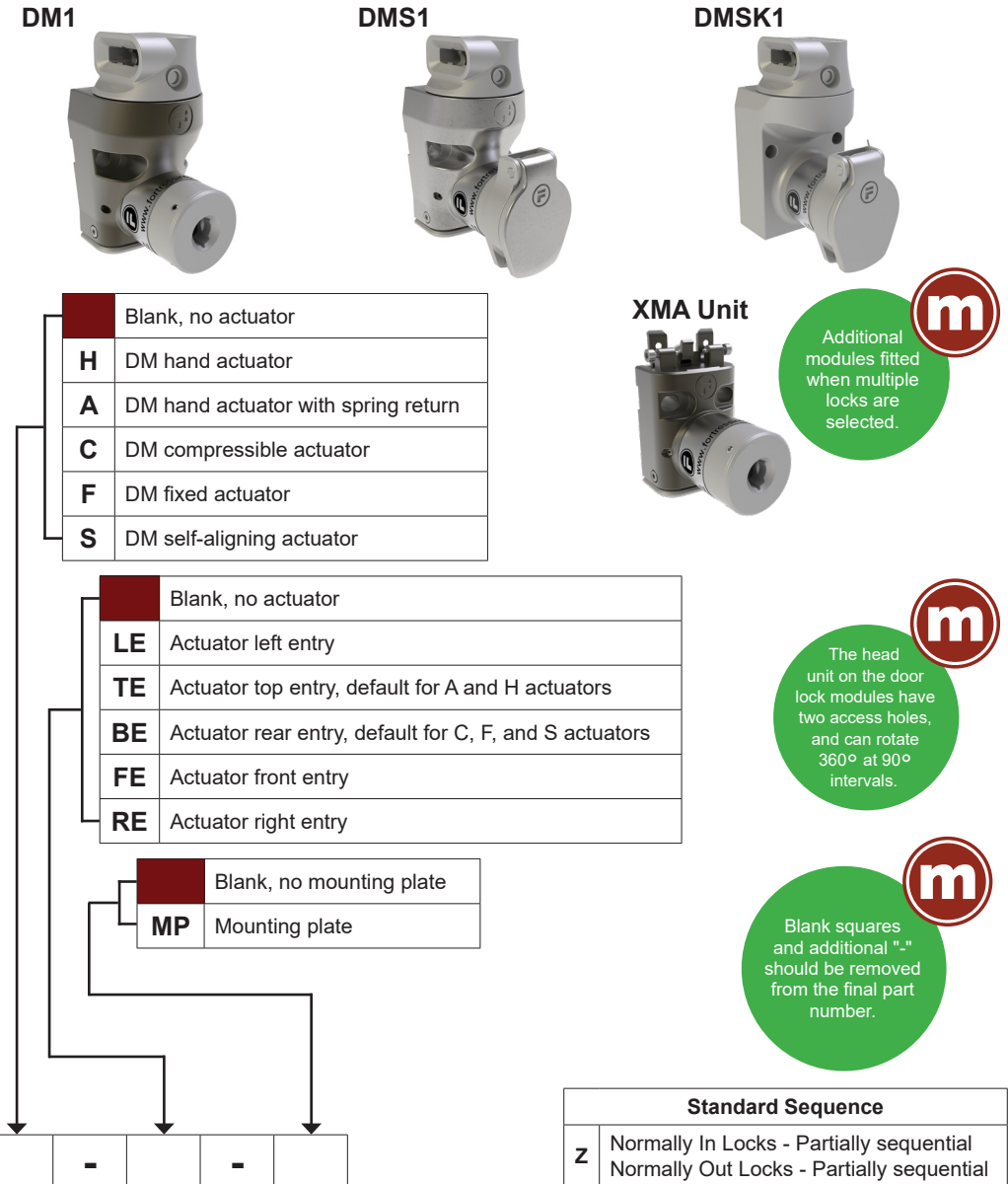
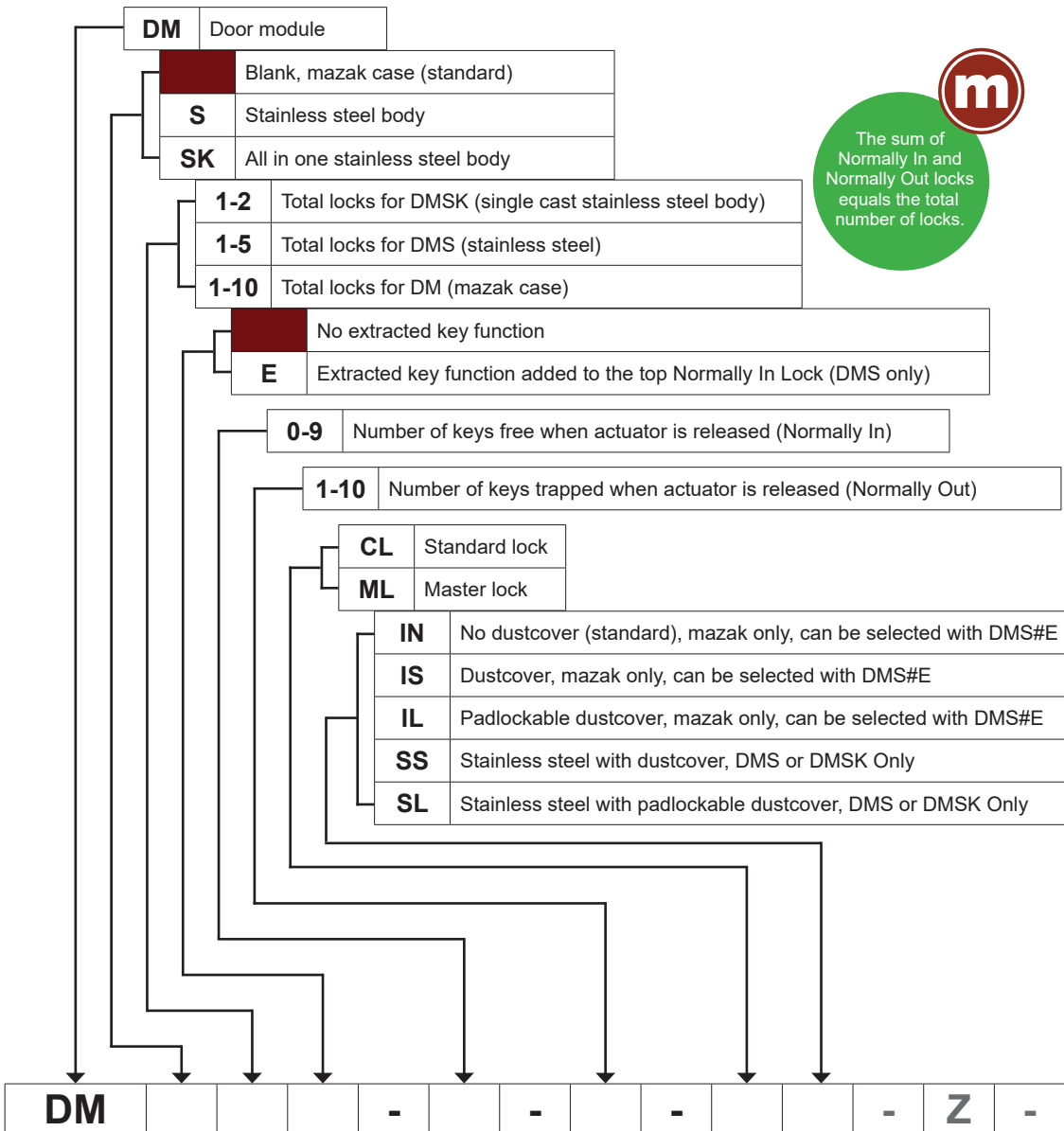

Standard Sequence	
<b>Z</b>	Normally In Locks - Partially sequential Normally Out Locks - Partially sequential

## Keys & Accessories

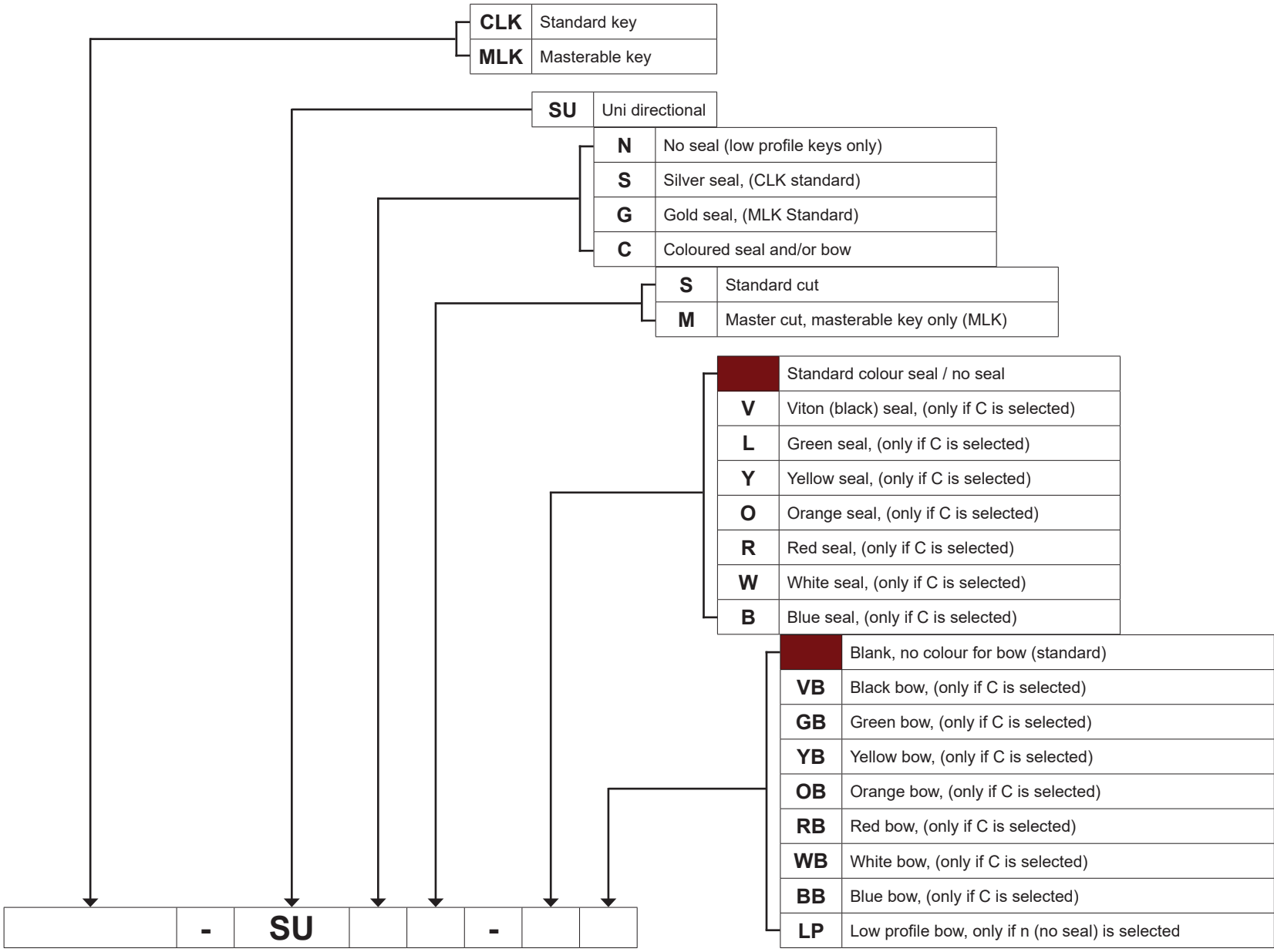

**CLK-SUSS**



**MLK-SUGS**

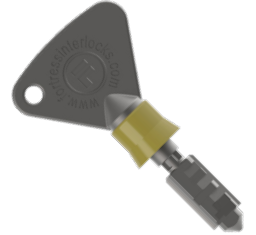

**MLK-SUCS-VYB**



**CLK-SUNS-LP**



Blank squares and additional "-" should be removed from the final part number.

## Keys & Accessories

Stainless Steel Dust Cover



Part Number  
**CLDC**

Stainless Steel Padlockable Dust Cover



Part Number  
**PLDC**

Lockout Scissor Hasp



Part Number  
**LOS3**

Lockout Scissor Hasp with Cable



Part Number  
**LOS3C**

Back of Board Adaptor

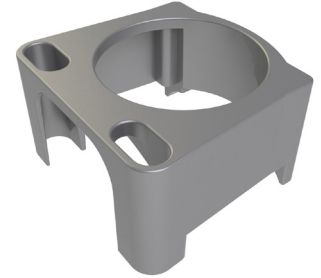

Part Number  
**M-BOB**

Add-On Lock Module



Part Number

<b>XMA-CLIN:</b> Mazak body, no dustcover
<b>XMA-CLIS:</b> Mazak body, dustcover
<b>XMA-CLIL:</b> Mazak body, padlockable dustcover

Stainless Steel Add-On Lock Module



Part Number

<b>XMSA-CLSS:</b> Stainless steel body, dustcover
<b>XMSA-CLSL:</b> Stainless steel body, padlockable dustcover



# FORTRESS

## FORTRESS

“ We have the peace of mind that our workers are safe and protected by Fortress equipment. ”



## FORTRESS

“ Fortress' best quality is providing each customer the most robust and safe solution - all while being completely customizable and retaining a high level of quality. ”



## FORTRESS

“ Fortress is best at providing customised solutions at a rapid turnaround - reacting immensely to a challenge to put the customer's needs first. ”



## FORTRESS

“ We value suppliers that can help navigate the standards and provide guidance that is directly linked to our applications. ”



## Fortress Global Offices and Manufacturing Facilities

[www.fortress-safety.com](http://www.fortress-safety.com)

### Fortress Interlocks Ltd

+44 (0)1902 349000

### Fortress Interlocks Pty Ltd

+61 (0)3 9771 5350

### Fortress Interlocks Europe

+31 (0)10 7536060

### Fortress Interlocks China

+86 (021) 6167 9002

### Fortress Interlocks USA

+1 (859) 578 2390

### Fortress Interlocks India

+91 7042358818

Contact us



## Notes